

ANEXO ÚNICO

**MANUAL DE MARCA  
GOV/SC 2024**

# I N D I C E

Estudo Revitalização Brasão	<b>03</b>
Marca	<b>10</b>
Marca Digital	<b>20</b>
Placas	<b>26</b>
Cartão Visitas	<b>30</b>
Marcas Secretarias	<b>31</b>
Aplicações Diversas	<b>36</b>

# ESTUDO DE REVITALIZAÇÃO DO BRASÃO DE ARMAS

## Brasão de Armas

Brasão de Armas, original como foi concebido em 1895 com a grafia "th" em "Catarina". Desenho rico em detalhes, com hachuras para dar volume.



Brasão estilizado "serigrafado" em 1953 para aplicação na atual bandeira do estado, perdendo todos os seus detalhes e volumes, pobre em traçado. A técnica utilizada para a estilização (não consta historicamente) acabou trazendo erros geométricos para o brasão.



## Brasão de Armas - Erros na estilização

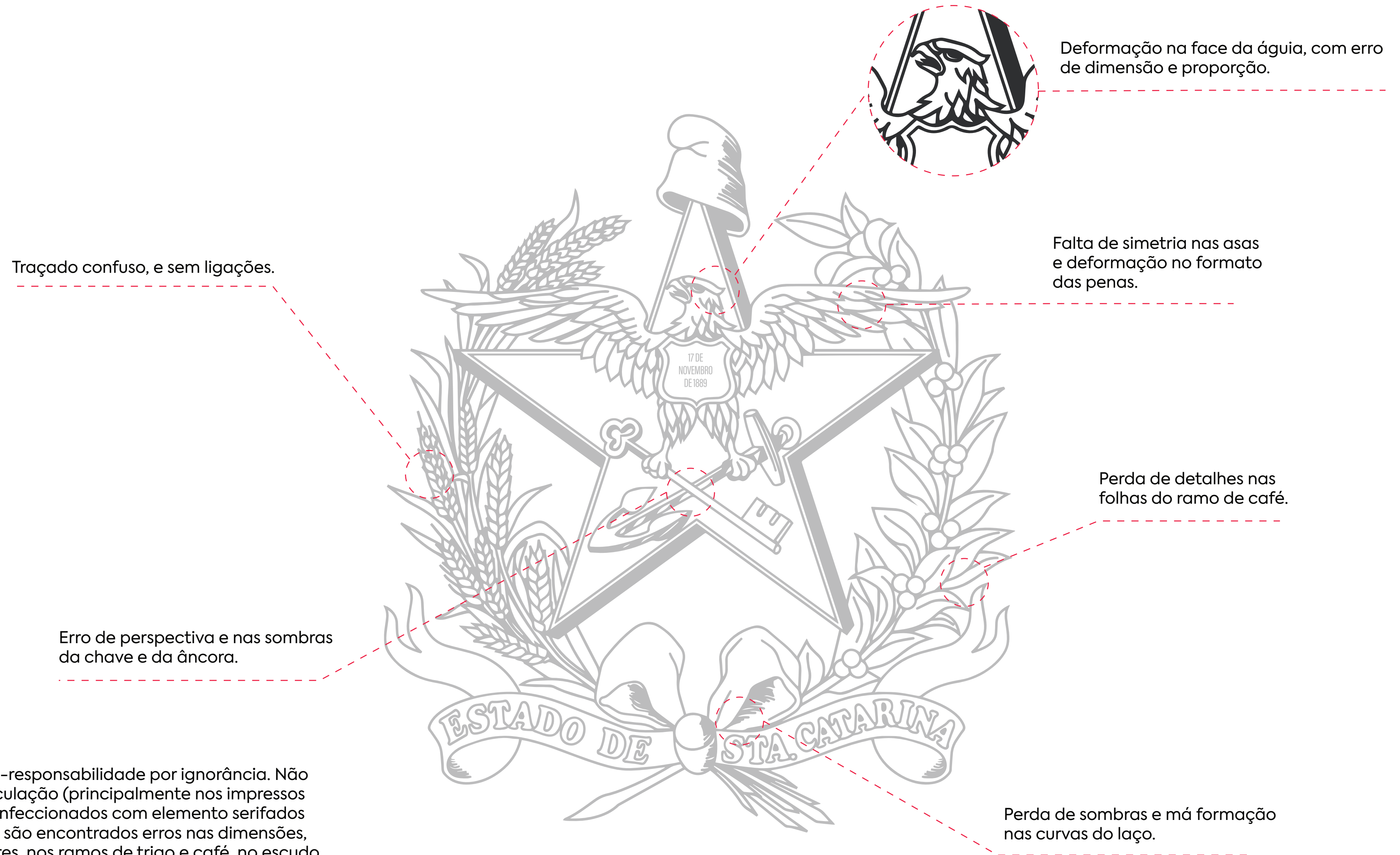

“É a concessão de auto-responsabilidade por ignorância. Não raro exemplares em circulação (principalmente nos impressos para escolares e nos confeccionados com elemento serifados para o uso em mastros) são encontrados erros nas dimensões, nas proporções, nas cores, nos ramos de trigo e café, no escudo, no barrete frígido e na estrela”

**A Águia Da Tua Bandeira - Theobaldo Jamundá (1988)**

**Brasão de Armas - Correção de estilização**



OUTLINE



Revitalização do brasão



# Malha da bandeira

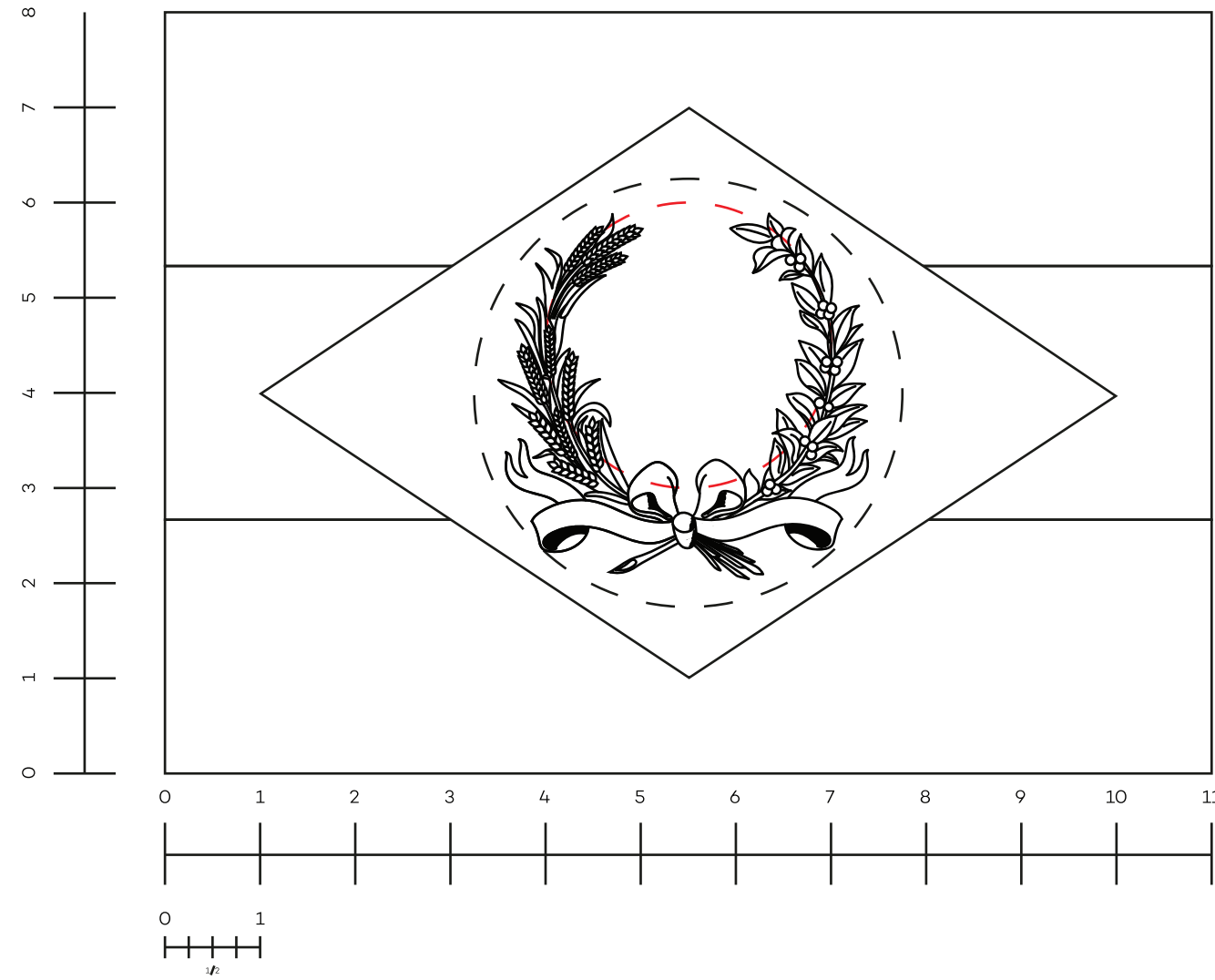
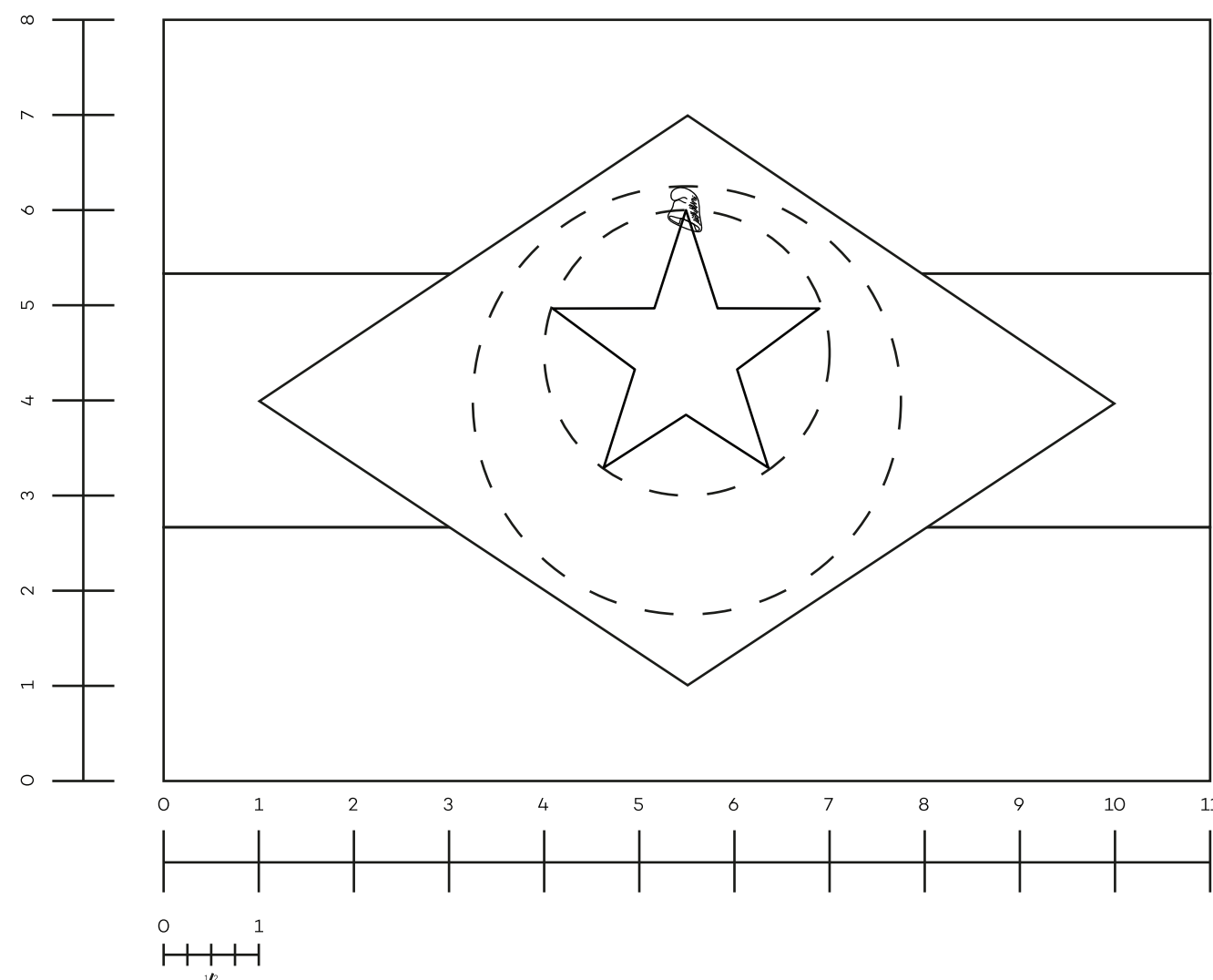
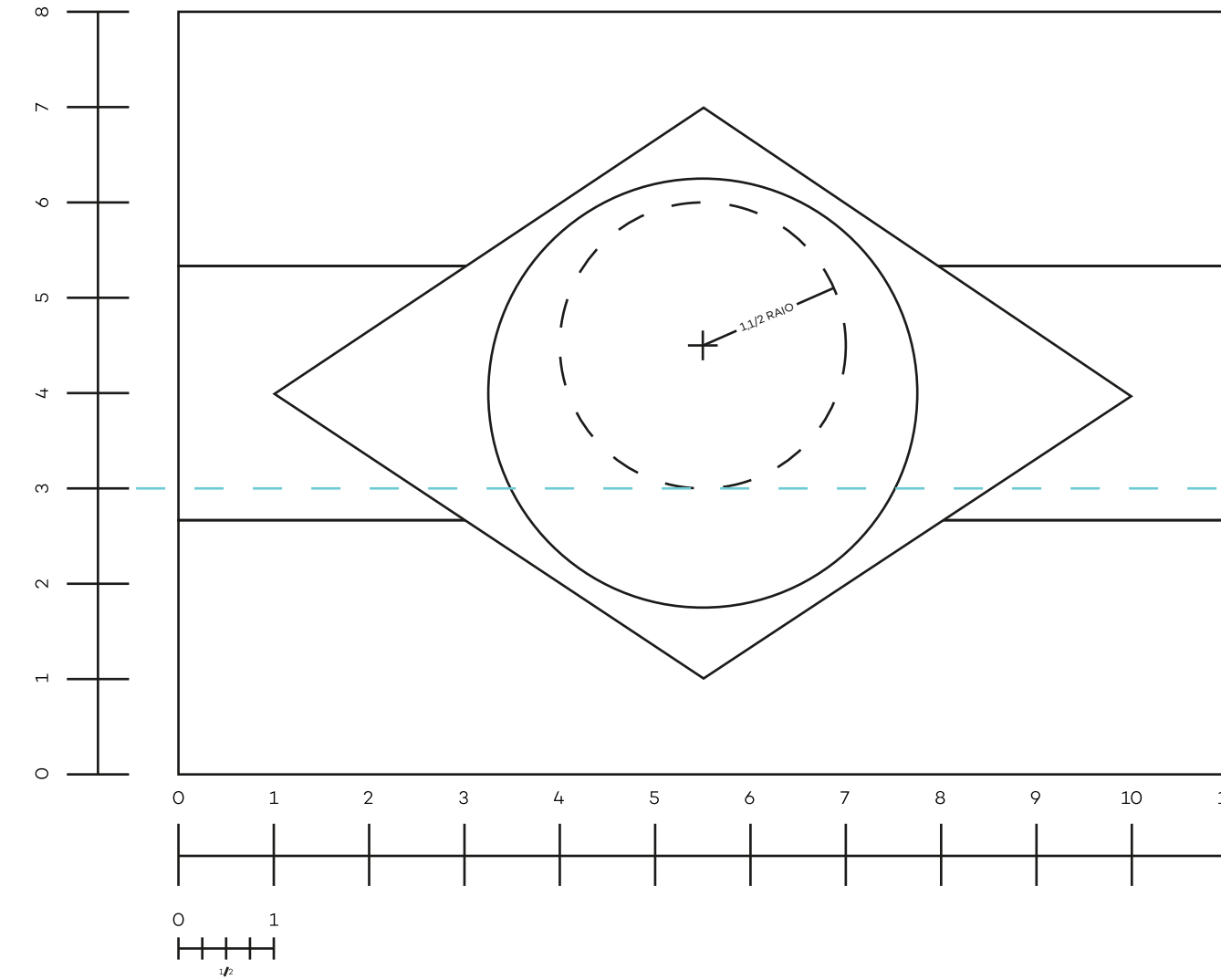
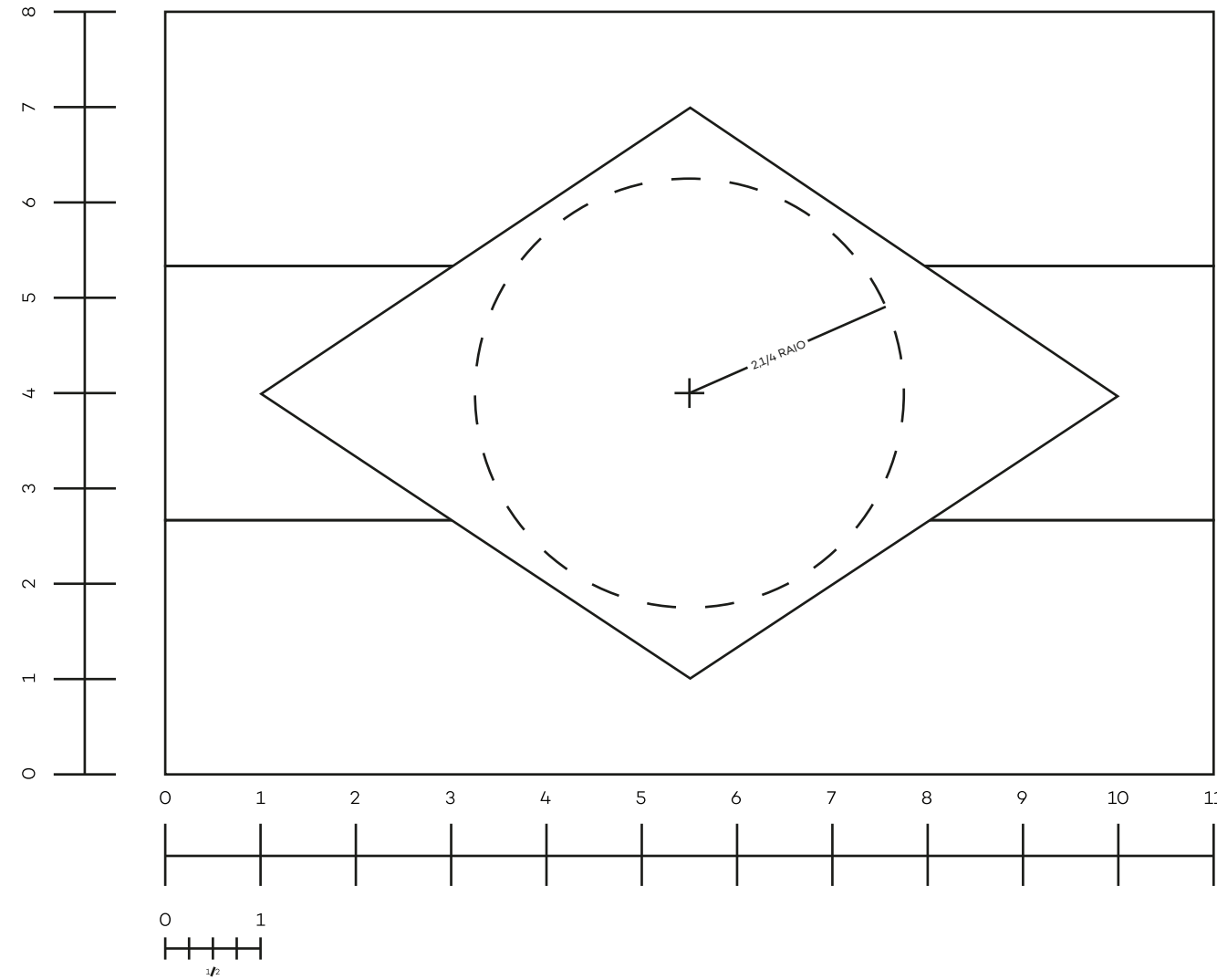
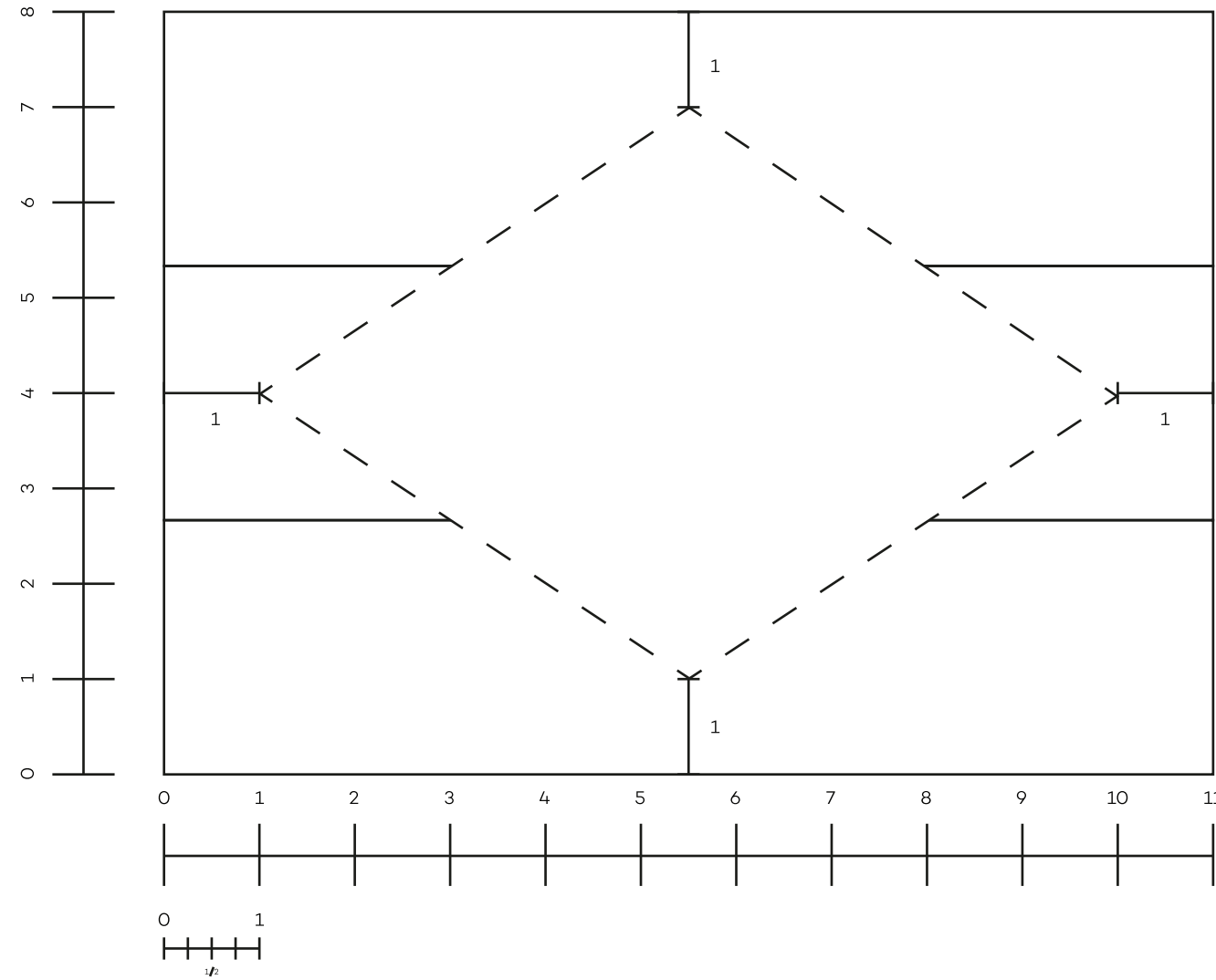

De acordo com o Decreto 605/1954, a bandeira do Estado de Santa Catarina é tripartida, com duas listras encarnadas e uma branca, alternadas, nas dimensões de 11 unidades de comprimento por 8 de largura. No centro dela dispõe um paralelogramo em verde claro, cujas pontas distam uma unidade de comprimento das bordas da bandeira. Dentro deste repousam as armas do estado, estando circunscritas em um círculo imaginário de 2,25 unidades de raio, de modo que o cruzamento da chave e da âncora se dê no centro da bandeira. O escudo das armas em forma de estrela se encontra inscrito num círculo, também imaginário, de 1,5 unidades, centrado a uma unidade de 0,375 acima do cruzamento da chave e da âncora.



*Bandeira da República Juliana (1839)*

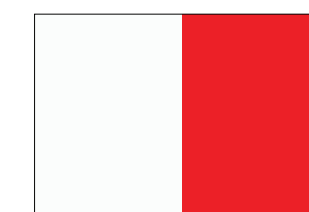

*Bandeira da província de Santa Catarina (até 1891)*

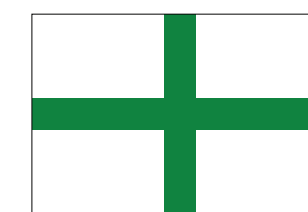

*Bandeira dos catarinenses na Guerra do Contestado (1912-1915).*



**Bandeira com brasão revitalizado**



**A MARCA**

**Linha do tempo das marcas**

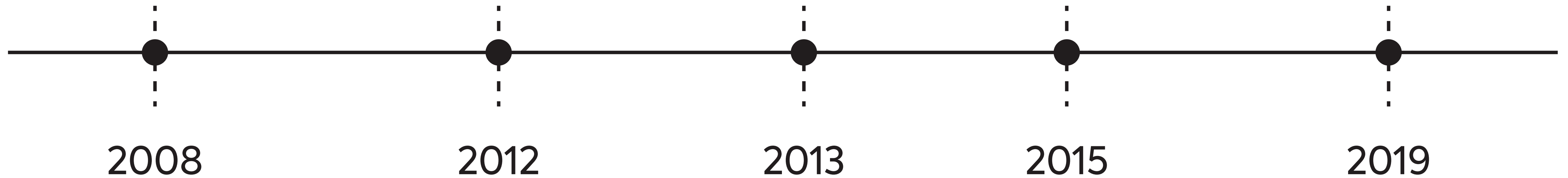



**GOVERNO DE  
SANTA  
CATARINA**

Malha construtiva

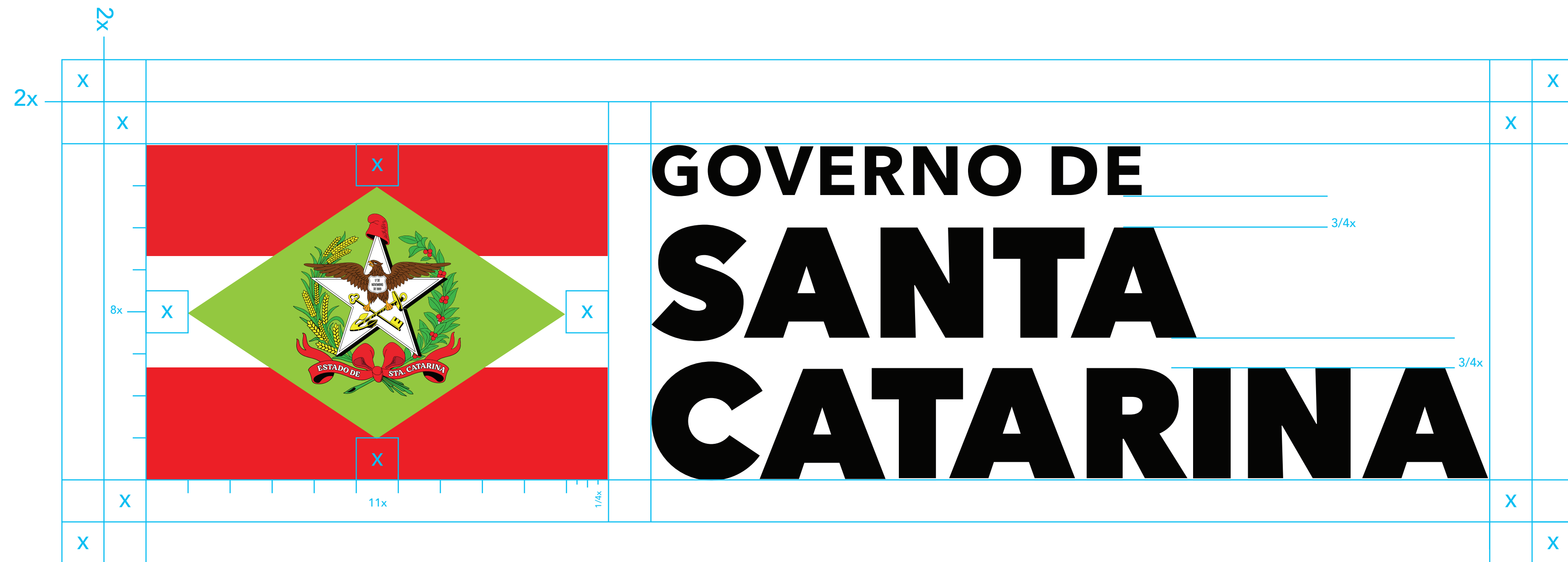

**Aa**

**AVENIR NEXT HEAVY**

**abcdefghijklmnopqrstuvxyz**  
**ABCDEFGHIJKLMNOPQRSTUVWXYZ**  
**0123456789**

**Aa**

**AVENIR NEXT BOLD**

**abcdefghijklmnopqrstuvxyz**  
**ABCDEFGHIJKLMNOPQRSTUVWXYZ**  
**0123456789**



# GOVERNO DE SANTA CATARINA

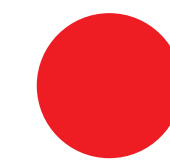

C:00 / M:100 / Y:100 / K:00  
R:215 / G: 56 / B: 51  
#ED1C24

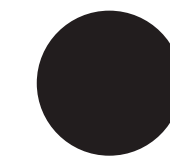

C:69 / M:68 / Y:64 / K:74  
R:35 / G: 31 / B: 32  
#231F20

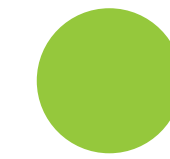

C:47 / M:00 / Y:100 / K:00  
R:161 / G: 200 / B: 77  
#A1C84D

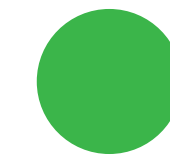

C:75 / M:00 / Y:100 / K:00  
R:95 / G: 177 / B: 87  
#5FB157

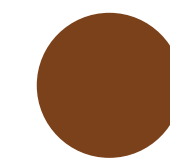

C:35 / M:75 / Y:100 / K:35  
R:115 / G: 65 / B: 20  
#744214

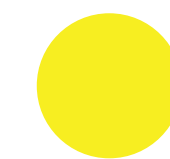

C:05 / M:00 / Y:95 / K:00  
R:115 / G: 65 / B: 20  
#FCEE21



K: 100

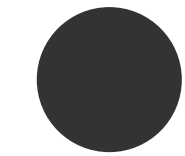

K: 90

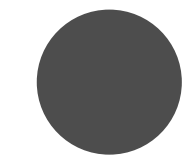

K: 70

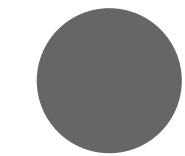

K: 60

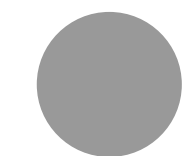

K: 50

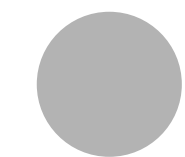

K: 30



K: 10





Área de proteção e Redução máxima



Aplicação em fundos coloridos e complexos



## Aplicações Inadequadas



Não alterar **COR**



Não alterar **PROPORÇÃO**



Não alterar **DISPOSIÇÃO**



Não **ACHATAR**



Não **COMPRIMIR**



Não **ALTERAR FONTES**



**GOVSC**

**Padrão de avatar para aplicações digitais**





**Governo do Estado de Santa Catarina** ✓

394 mil seguidores • 155 seguindo

 Seguindo

 Pesquisar







**GOVERNO DE**  
**SANTA**  
**CATARINA**

← Responder

→ Encaminhar

**Nome do Secretário | Nome Servidor**

Secretaria De Estado da Administração Prisional  
Nome / Vice-presidência de Tecnologia  
Telefone: +00(00) 0000-0000 / +00(00) 999999-9999



# Lorem ipsum dolor sit amet, consectetur a Lorem ipsum dolor sit amet

Lorem ipsum dolor sit amet, consectetur adipiscing elit, sed diam nonummy nibh euismod tincidunt ut laoreet dolore magna aliquam erat volutpat. Ut wisi enim ad minim veniam, quis nostrud exerci tation ullamcorper suscipit lobortis nisl ut aliquip ex ea commodo consequat.

Duis autem vel eum iriure dolor in hendrerit in vulputate velit esse molestie consequat, vel illum dolore eu feugiat nulla facilisis at vero eros et accumsan et iusto odio dignissim qui blandit praesent luptatum zzril delenit augue dui dolore te feugait nulla facilisi.

Lorem ipsum dolor sit amet, consectetur adipiscing elit, sed diam nonummy nibh euismod tincidunt ut laoreet dolore magna aliquam erat volutpat. Ut wisi enim ad minim veni

## Padrão sinalização interna: Portas e Banheiros

Imagem de perfil



Aplicar marca da sua Secretaria nas placas



Placa 20x15cm - Acrílico leitoso 2mm com impressão UV

Fonte: Avenir Next Bold

Placa 18x19cm - Acrílico leitoso 2mm com impressão UV

Placa 20x4cm - Acrílico leitoso 2mm com impressão UV



Placa 42x7cm - Acrílico leitoso 2mm com impressão UV

Fonte: Avenir Next Bold

38x8cm - Acrílico leitoso 2mm com impressão UV

Placa 42x4cm - Acrílico leitoso 2mm com impressão UV

Modelo na proporção 3x1 módulos texto em tipos da família avenir centralizado nos dois módulos da direita no valor de 1/5 de módulo

 <b>GOVERNO DE SANTA CATARINA</b>			<h1>DESCRIÇÃO DA OBRA</h1>				
Convênio N° 000.000-00			Valor: R\$ 0.000.000,00				
Recurso Estadual: R\$ 0.000.000,00			Contrapartida: R\$ 0.000.000,00				
Concedente: <b>Nome do Concedente</b>			Órgão/Entidade Executora: <b>Nome da Entidade</b>				
Prazo execução: <b>000 dias</b>		Início: <b>00/00/0000</b>		Término: <b>00/00/0000</b>			
Construtora: <b>Nome da Empreiteira</b>			Mais informações: <b><a href="http://www.sctransferencia.sc.gov.br">www.sctransferencia.sc.gov.br</a></b>				

## Padrão placas de Identificação (Emenda Impositiva)

De acordo com a determinação do Decreto Nº 1684, de 21 de janeiro de 2022.

**NOME DO OBJETO DE EXECUÇÃO** - Descrever a obra em questão: ponte, duplicação, asfalto, calçamento, etc.

**LOGOMARCA DO MUNICÍPIO** - Aplicar a logomarca do município parceiro - de preferência na versão horizontal - dentro da área delimitada.

- Deletar o retângulo de marcação.

<b>NOME DO OBJETO DE EXECUÇÃO</b>		MODALIDADE: <b>CONVÊNIO</b>	
<b>ESSA OBRA CONTA COM RECURSOS DO GOVERNO DO ESTADO.</b>			
Número do Convênio: <b>0000000000000000</b>		Ano: <b>0000</b>	
Valor total: <b>R\$ 000.000.000,00</b>		EXECUÇÃO:	
Repasso do Estado: R\$ 000.000,00		<b>APLICAR AQUI A LOGOMARCA DO MUNICÍPIO</b>	
Contrapartida do Município: R\$ 000.000,00		PARTICIPAÇÃO ORÇAMENTÁRIA:	
		 <b>GOVERNO DE SANTA CATARINA</b>	

RGB			PANTONE			CMYK			
■ R 33	G 86	B 14	■ 21560E			■ C - 85	M - 40	Y - 100	K - 40
■ R 252	G 106	B 6	■ FC6A06			■ C - 0	M - 69	Y - 95	K - 0
■ R 56	G 142	B 20	■ 388E14			■ C - 78	M - 18	Y - 100	K - 5

**Proporção 3 x 1**  
Texto em tipos da família Montserrat.

## Padrão placas de Identificação (Convênio)

De acordo com a determinação do Decreto Nº 1684, de 21 de janeiro de 2022.

**NOME DO OBJETO DE EXECUÇÃO** - Descrever a obra em questão: ponte, duplicação, asfalto, calçamento, etc.

**LOGOMARCA DO MUNICÍPIO** - Aplicar a logomarca do município parceiro - de preferência na versão horizontal - dentro da área delimitada.  
- Deletar o retângulo de marcação.

<b>NOME DO OBJETO DE EXECUÇÃO</b>		<b>MODALIDADE: EMENDA IMPOSITIVA</b>	
<b>ESSA OBRA CONTA COM RECURSOS DO GOVERNO DO ESTADO.</b>			
Número da Emenda: <b>000000000000</b> Ano: <b>0000</b>		Nº da Lei Orçamentária Anual: <b>000000000000</b>	
Valor total: <b>R\$ 000.000.000,00</b>		EXECUÇÃO:	
Repasse do Estado: R\$ 000.000,00		<b>APLICAR AQUI A LOGOMARCA DO MUNICÍPIO</b>	
Contrapartida do Município: R\$ 000.000,00			
			

RGB			PANTONE			CMYK			
■ R 33	G 86	B 14	■ 21560E			■ C - 85	M - 40	Y - 100	K - 40
■ R 249	G 176	B 15	■ F9B00F			■ C - 0	M - 35	Y - 93	K - 0
■ R 56	G 142	B 20	■ 388E14			■ C - 78	M - 18	Y - 100	K - 5

### Proporção 3 x 1

Texto em tipos da família Montserrat.

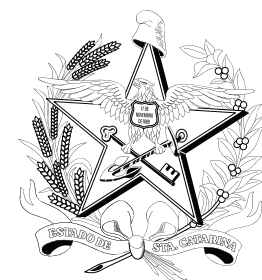

**GOVERNO DO ESTADO DE SANTA CATARINA**

**NOME SOBRENOME**  
CARGO + SECRETARIA

Rod. SC 401, km 05, nº 4.600 Florianópolis - SC / CEP 88.030-901  
(48) XXXXXXXX - nono@nonono.sc.gov.br -  @governosc



GOVERNO DE  
**SANTA  
CATARINA**  
SECRETARIA DA SAÚDE



GOVERNO DE  
**SANTA  
CATARINA**  
SECRETARIA DA ADMINISTRAÇÃO  
PRISIONAL E SOCIOEDUCATIVA







**SES**  
SECRETARIA DA SAÚDE



**SAP**  
SECRETARIA DA ADMINISTRAÇÃO  
PRISIONAL E SOCIOEDUCATIVA



**SES**  
SECRETARIA DA SAÚDE



**SAP**  
SECRETARIA DA ADMINISTRAÇÃO  
PRISIONAL E SOCIOEDUCATIVA



Secretaria da Saúde

Secretaria da Administração  
Prisional e Socioeducativa



**SES**  
**SAP**



**Marcas Secretarias (+ marca complementar): Adesivos Frota**





GOVERNO DE  
**SANTA**  
**CATARINA**